

Montageanleitung

Wandschrank Innen A4 PHZ Doppelschwenkhebel (Art.Nr.: 1004400)

(Beipack: 4x Spenglerschraube 4,5x45 mit A2 Dichtscheibe, 4x Nypondübel 6x30, 2x Senkschraube M5x16, Folienaufkleber „Feuerwehrpläne“ gemäß DIN 4066)

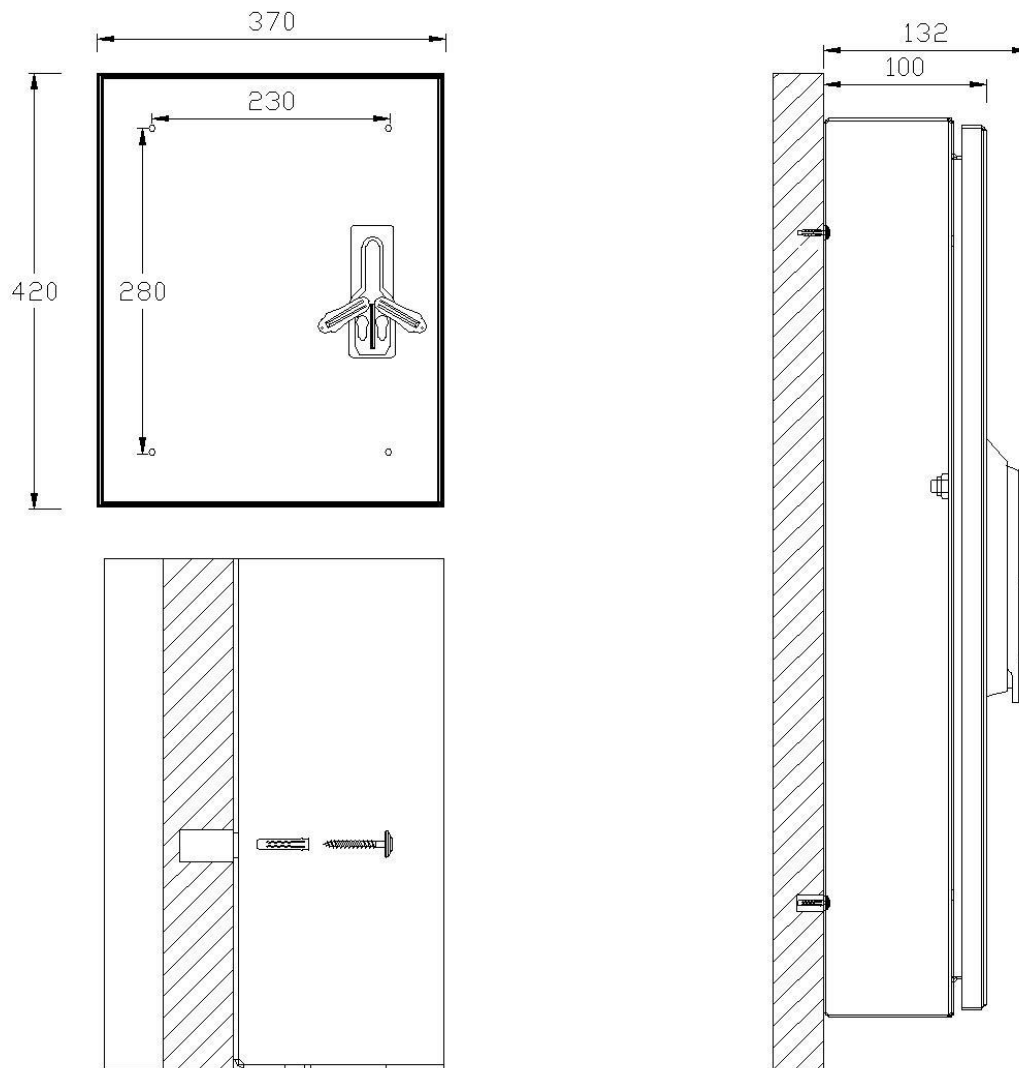

Profilhalbzylinder auf 180 ° bei Schlüsselabzug einstellen.

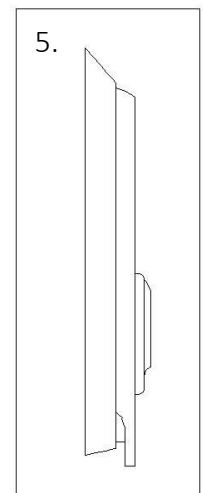
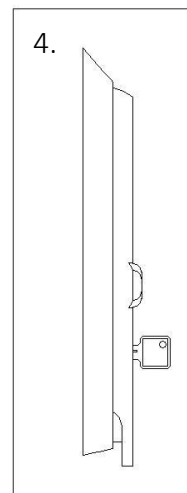
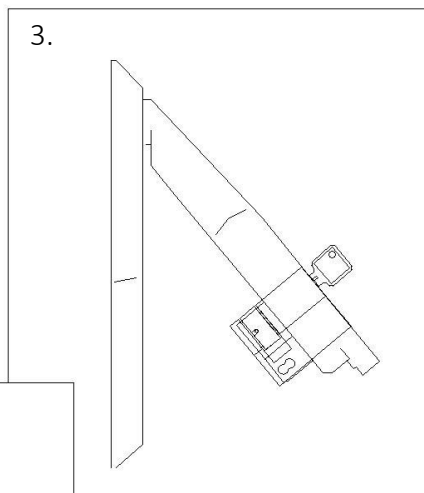
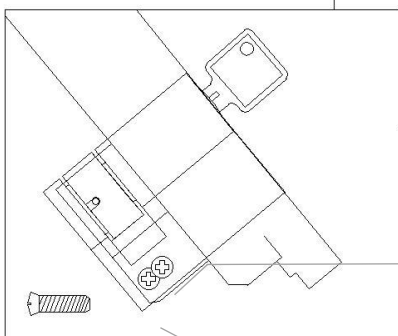
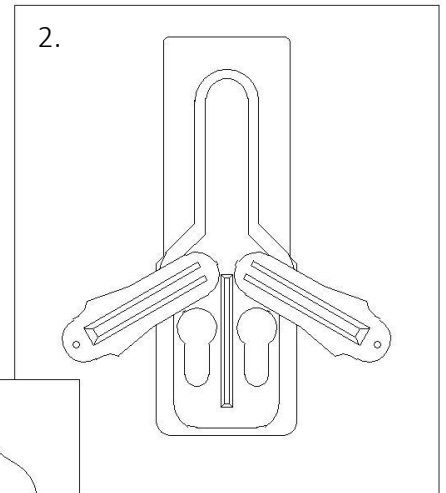
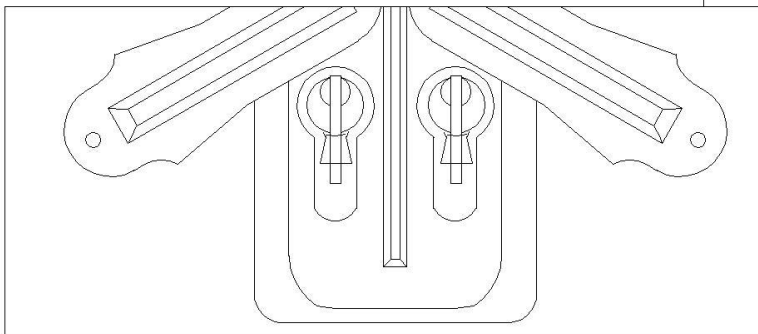
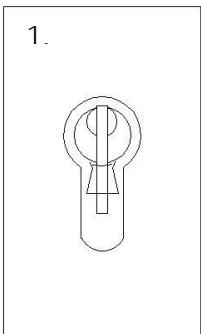

Senkschraube bei Profilhalbzylinder (30/10) 40 mm

Senkschraube bei Profilhalbzylinder (35/10) 45 mm